

memmert

OPERATING INSTRUCTIONS

Electronically controlled drying ovens

UE 200 - 800

ULE 400 – 800

Electronically controlled sterilisers

SE 200 - 400

SLE 400 – 800

Electronically controlled incubators

BE 200 – 800



TABLE OF CONTENTS

1	Congratulations on your choice of a MEMMERT Oven!	2
2	The equipment of Memmert cabinets Series UE, BE, SE. ULE, SLE consists of:	3
2.1	Electrical supply	4
2.2	Installation options (special equipment)	5
2.3	Wall mounting (special equipment)	5
2.4	Stacking device (special equipment)	6
3	Putting into operation	6
4	Main switch module with fresh air control	7
5	Working controller module	8
6	Working controller module in main switch position I	9
7	The serial communication interface	10
7.1	Communication protocol	10
7.2	Computer connection	10
7.3	RS232C interface	10
8	Controller module with main switch in position 	11
9	Setting of continuous operation and programmes (offline operation)	13
9.1	Programming of a switch-off delay	13
9.2	Programming of a switch-off delay, dependent on set temperature	13
9.3	Programming of a switch-on delay	14
9.4	Programming of a switch-on delay and a hold time	14
9.5	Switch-on delay and hold time dependent on set temperature	15
9.6	Programming of a switch-on delay and hold time with Loop-function	15
9.7	Programming of a switch-on delay and hold time with Loop-function and set temperature dependent operation	16
10	Supervision of the program flow (offline operation)	17
10.1	Further information during program operation:	18
10.2	End of the program / Restart:	18
11	Safety devices	19
11.1	Adjustable overheat controller (TWW), class 3.1 according to DIN 12880	19
11.2	Adjustable temperature limiter (TWB), class 2 according to DIN 12880	20
12	Loading	21
13	Sterilisers	22
13.1	Application	22
13.2	Directives for sterilisation in MEMMERT- hot-air sterilisers	22
13.3	Notes on the work with sterilising cassettes:	23
14	Sterilisation programme	24
14.1	Example – Steriliser SLE 600:	24
15	Door interlock (option)	25
16	Maintenance	26
16.1	Readjusting the door	26
17	Cleaning	27
18	Check list for rectifying faults	27
19	Our Address	28
20	Index	32
21	Glossar:	33



The text of these Operating Instructions has been translated from the German. If any part of the text is doubtful or the interpretation is unclear, and also in case of errors, the German original is to be considered as valid.

1 Congratulations on your choice of a MEMMERT Oven!

Manufactured in Germany using the latest production techniques and finest materials available, you now possess a technically superior and fully developed product. Your oven has already been under extensive testing in our factory.

For correct operation of the equipment it is essential to observe the operating and maintenance instructions below. This will ensure that your equipment will give many years' satisfactory service.



Explanation of symbols:

These symbols mark important indications in the operating instructions

The corresponding markings on the unit mean:

Note the Operating Instructions!
Attention, outside case temperature may be hot!



General safety instructions:

The physical and chemical properties of your load (e.g. inflammation temp. etc.) have strictly to be observed, as otherwise considerable damages (load, oven, surroundings of apparatus) can appear.



Please note that the Memmert ovens described here are not explosion-proof (they do not conform to Occupational Association Regulation VBG 24). They are therefore unsuitable for drying, evaporating or burning-in of enamels or similar substances whose solvent may form an inflammable mixture together with air. There must be no possibility for inflammable or explosive gas/air mixtures to form either inside the cabinet or in the immediate neighbourhood of the equipment.



Excessive dust or aggressive vapours in the interior and/or around the oven may result in sediments within the oven and cause short circuits or damage to the electronic parts. Therefore dust and aggressive vapours should be kept from the unit.



Transport:

Always use gloves !

If the ovens have to be carried, at least 2 persons are required for this mode of transportation depending on size for Models 200 to 500. At least 4 persons are required for Models 600 and 700.



ATTENTION !

Take special care when oven is working at high temperature!
Outside case temperature may be hot!



2 The equipment of Memmert cabinets Series UE, BE, SE, ULE, SLE consists of:

- electronic PID controllers with programmable start-up delay and hold time, set temperature dependent operation and repeat function. The controller incorporates permanent power matching and a time-saving self-diagnostic system for rapid fault finding (see checklist)
- a built-in timer for digital programme time selection up to 999 hours
- RS232 interface according to DIN 12900-T1 for computer controlled and recorded thermostating programmes with the MEMMERT software „CELSIUS for WINDOWS®“ (installation diskette and handbook)

The fan can be operated in two ways:

- the fan can be switched on and off on the cabinet (in offline operation) or by the programme
- with PC control via the interface using the MEMMERT „CELSIUS for WINDOWS®“ (online operation) the fan speed can in addition be adjusted by the programme in 10% steps.

Technical data summary

A Pt 100 DIN A in 4-wire circuit measures the temperature in the working chamber. The temperature-set-accuracy is 0,1°C for BE types and 1°C UE/SE and ULE/SLE types.

Ovens Series UE/SE/BE have natural air circulation.

Series ULE/SLE ovens have circulation assisted by a fan.

Ambient conditions Ambient temperature 5°C - 40°C, rh max. 80%. Overvoltage Category II. Contamination degree: 2 according to IEC 664

Setting temperature range 20°C to nominal temperature (See rating plate).

Min. working temperature range A stable temperature control of ovens **without fan** resp. **with fan switched-off** can be guaranteed from 5°C above ambient temperature. When the fan of the models ULE / SLE is switched on, the working temperature can be set from 10°C degrees above ambient up to the nominal temperature = maximum temperature (according to rating plate).

Max. working temperature range Nominal temperature = maximum temperature (see rating plate).

Overheat safety device Serial adjustable overheat control in compliance with DIN 12880 Class 3.1; Class 2 protection (adjustable temperature limiter) available on request.

Class	Aim of protection	Scope of protection	Safety device	Safety measures
2	Protection of the oven, the environment and the contents of the oven	No risk liable to originate from the oven in the event of a fault	TWB (adjustable temperature limiter) automatically shuts off the oven if the user selected temperature limit is exceeded.	Special safety measures required depending on the purpose for which the oven is used
3.1		The contents of the oven are protected against overheating	TWW (adjustable overheat controller) takes over control of oven if temperature is exceeded.	



2.1 Electrical supply

50 or 60 Hz. Adequate insulated supply which incorporates earth conductor according to EN 61010, Protection IP 20, no humidity protection according to DIN 40 050. Interference suppression Grade N according to VDE 0875, limiting values of the classe B, part one.

A fuse 250V/15A quick is used for unit protection (in units with 400V 3N~ power supply 3 fuses).

Before current-connection please compare label on the oven and instructions of your local current supplier.

(e.g. in Germany, DIN VDE 0100 with FI - safety device).

model	volume	current consum.	power	voltage $\pm 10\%$	weight
UE/SE 200	32 l	4,8 A	1100 W	230 V~	28 kg
UE/SE 300	39 l	5,2 A	1200 W	230 V~	30 kg
UE/SE/ULE/SLE 400	53 l	6,1A	1400 W	230 V~	35 kg
UE/ULE/SLE 500	108 l	8,7 A	2000 W	230 V~	50 kg
UE/ULE/SLE 600	256 l	10,4 A	2400 W	230 V~	87 kg
UE/ULE/SLE 700	416 l	5,8 A	4000 W	400 V 3N~	121 kg
UE/ULE/SLE 800	749 l	7,0 A	4800 W	400 V 3N~	164 kg

BE 200	32 l	1,9 A	440 W	230 V~	28 kg
BE 300	39 l	2,2 A	500 W	230 V~	30 kg
BE 400	53 l	3,5 A	800 W	230 V~	35 kg
BE 500	108 l	3,9 A	900 W	230 V~	50 kg
BE 600	256 l	7,0 A	1600 W	230 V~	87 kg
BE 700	416 l	7,8 A	1800 W	230 V~	121 kg
BE 800	749 l	8,7 A	2000 W	230 V~	164 kg

This equipment is intended for operation on a supply system with a system impedance Z_{max} at the transfer point (building connection) which does not exceed 0.12 Ohm. The user has to ensure that the equipment is being operated on a supply system which meets this requirement. If necessary, details of the system impedance can be obtained from the local power supply authority.

Quality of material

Memmert is using stainless steel (Spec. 1.4301) for the external casing as well as for the interior, an outstanding material because of its high stability, optimum hygienic features and corrosion resistance against many (not all!) chemical combinations (Attention e.g. at chlorine combinations!).



WARNING!

Before removing top cover – pull out plug !



2.2 Installation options (special equipment)



Do not place the steriliser on a readily inflammable support!

The cabinet can be set up on the floor or on a table (bench), model 500 - 700 on a subframe. Ensure at least 150 mm clearance between back of oven and wall. The distance between ceiling and oven should not be less than 200 mm and the minimum wall spacing to the sides is 80 mm.

Generally, a sufficient circulation of air around the unit is required.

After the cabinet has been set up horizontally the door can be adjusted if required (**see chapter - MAINTENANCE**).

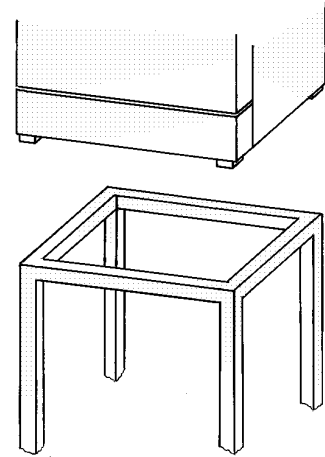

The model 800 is movable. The front castors are lockable by means of a fixation. In order to assure stability, the front castors **must always be adjusted to the front side** of the oven for locking.

2.3 Wall mounting (special equipment)

Up to model 700 for all ovens metal mounting brackets (see Fig. a) are available. A mounting bracket is delivered with an incombustible plate. The dimensions of the fixing screws are to be chosen depending on the total weight (equipment and loading) of the charge and the quality of the wall.

Pitches of holes for wall fixation (wall bracket)

model	A		B		C	
	mm	inch	mm	inch	mm	inch
200	489	19,25	770	30,32		
300	569	22,40	770	30,32		
400	489	19,25	850	33,47	-	-
500	649	25,55	930	36,61	-	-
600	889	35,00	1090	42,91	540	21,26
700	1129	44,45	1250	49,21	410	16,14

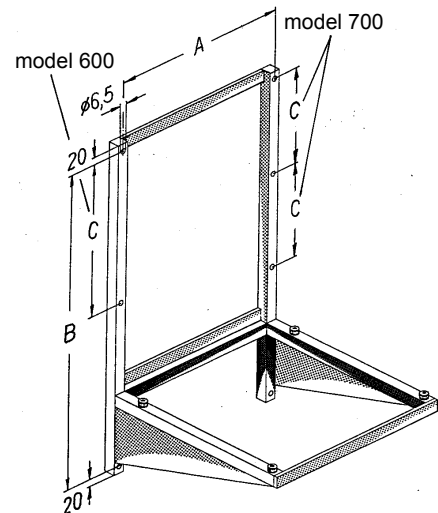



2.4 Stacking device (special equipment)

Where the requirement is for two ovens of the same size to be placed one on top of the other, the oven with the lower working temperature should be placed on the bottom .

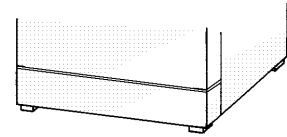

Mounting:

- Remove the top of the bottom oven and turning it upside down place the drilling jig into the back corner. Mark out the hole position and drill a 4,2 mm diameter hole.

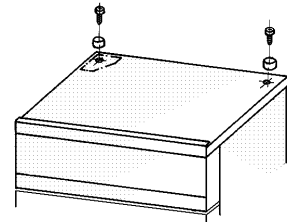

- With the screws provided fix the centering cylinders into position. Re-fix top cover.
- Model 700 can only be stacked with an intermediate frame.

3 Putting into operation



Attention !

Extremely strong shocks during transport can cause a displacement of the temperature sensors in the holding clips inside the working space.

Take care before the first putting into operation that the temperature sensors are checked on their correct position and if necessary are slid cautiously backwards or forwards in the holding clip (see fig.).

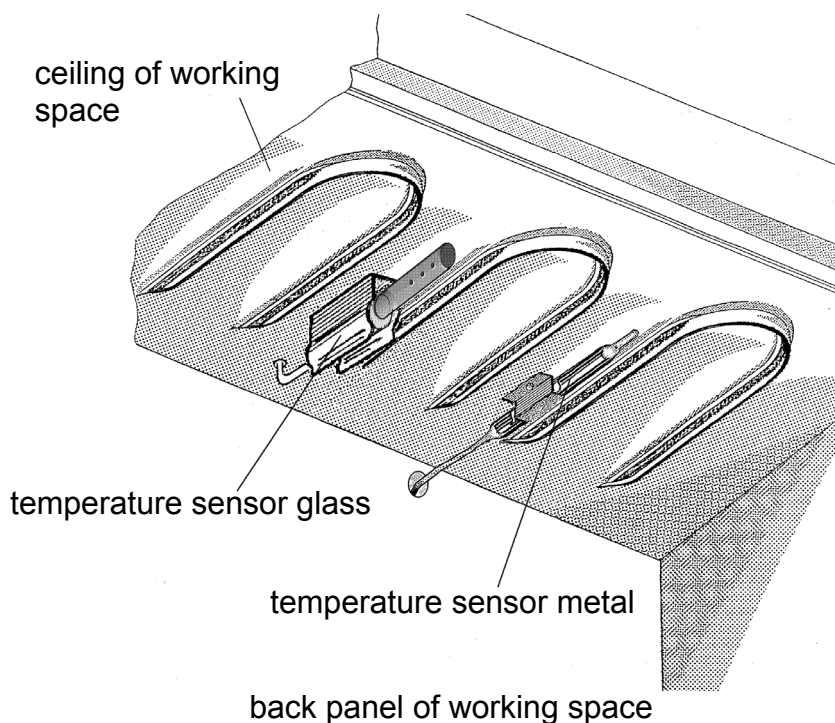

Handling of the door

The door is opened by pulling the door knob, and is closed by pushing in the door knob.



Attention!

When the oven is started up for the first time it should be run under supervision until steady conditions are reached.



4 Main switch module with fresh air control

The main switch module contains:

- main switch to select the working mode
- three signal lamps for display of the unit status
- slide knob for fresh air control

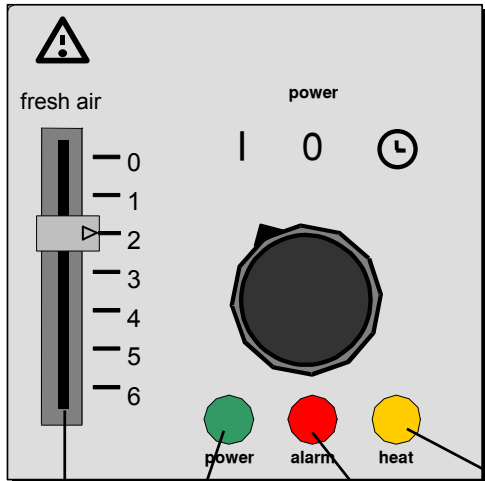

- **Main switch in position 0:**
unit is shut down
- **Main switch in position I:**
continuous operation
operation from PC with „CELSIUS for WINDOWS®“
- **Main switch in position ⌚:**
programmed operation (offline operation)

The previous setpoint is indicated briefly on the Controller Display after switching on.

Green:
ready for operation

Red:
fault indicator

Yellow:
unit is heating

fresh air

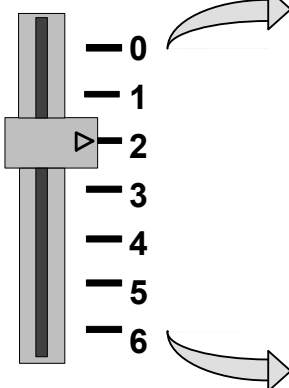

Flap closed: virtually no through ventilation.

Intermediate positions: the air in the chamber is renewed to a limited extent.

Maximum fresh air ventilation, but **no** complete change of air within the chamber (in units with an air turbine by max. rotation speed).



5 Working controller module

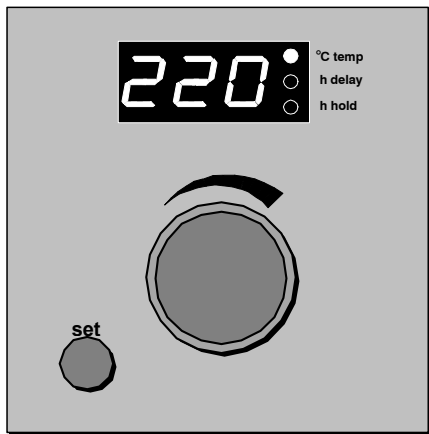

The controller is operated with the aid of the digital rotary knob in conjunction with the set-button, as described in the subsequent chapters.

The multifunction display provides information on temperature and programme settings.

The functions for different settings of the main switch are described below.

NOTES :

- If the set-button is not operated, the controller display shows the actual temperature.
- Changing the displayed setpoint is only possible, if the set-button is held down at the same time. This helps to avoid unintentional changes.
- Turning the rotary knob rapidly changes the setpoint in large steps; turning it slowly changes the setpoint in single digits.
- When the programming is finished the set values are stored, stay in the memory and remain stored even if the cabinet is switched off.



6 Working controller module in main switch position I

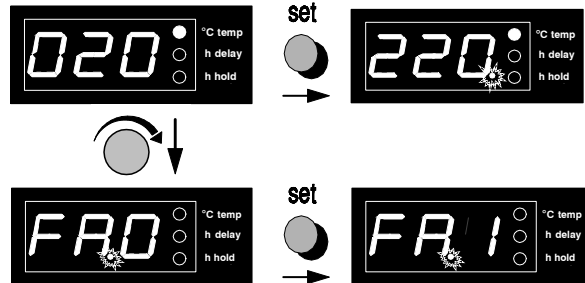
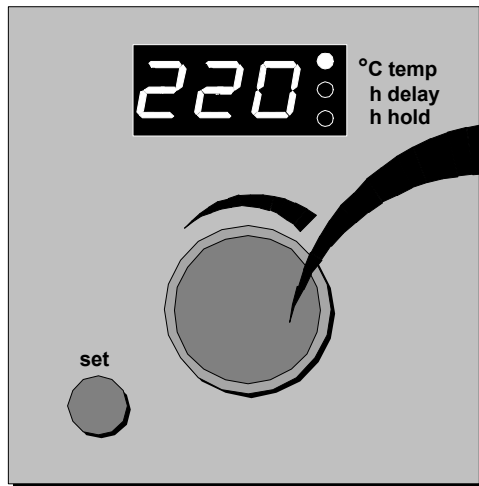
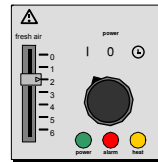

- Rotation of the knob while pushing the **set**-button sets the required temperature. The decimal point in the display is flashing.
- After releasing the **set**-button the setpoint remains on the display for approx. 3 seconds and is then stored. The decimal point in the display is flashing.
- The decimal point stops flashing and the controller switches to display of the actual temperature.
- On cabinets with fan, the fan can be switched on to run continuously or switched off.
FA0 = fan continuously off - *FA.1* = fan continuously on.
- The cabinets can be operated and programmed with the MEMMERT software „**CELSIUS for WINDOWS®**“ via the serial interface and using a PC In this operating mode the fan speed can be adjusted in 10% steps on cabinets with fan.

Note !

If the cabinet is being operated from a PC via the serial interface and a thermostating programme is started in the main programme window in the MEMMERT software „**CELSIUS for WINDOWS®**“, the set parameters can only be viewed on the controller but can no longer be altered.

On pushing the set-button the display shows:

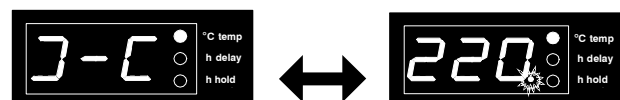

For further information refer to the enclosed handbook „**CELSIUS for WINDOWS®**“



7 The serial communication interface

7.1 Communication protocol

The communication protocol of the MEMMERT controllers has been defined in accordance with the rules of the Standards Working Party for Measurement and Control in the chemical industry (NAMUR).

7.2 Computer connection

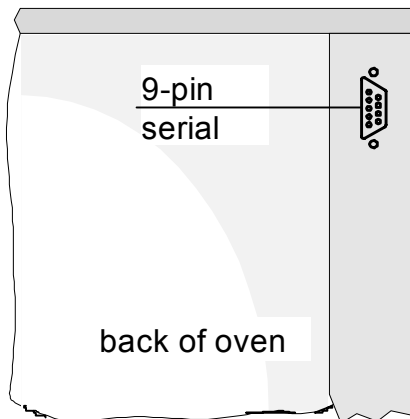

A **serial interface** located on the back panel of the cabinet (see illustration) is provided to link your Type E cabinet to the PC.

The cabinet can be connected to the PC using a commercially-available standard connecting cable (3 m). It is important to use a shielded cable. The shield must be connected to the plug case.

If the serial interface is not used, the connector must be covered with the protection cap.

7.3 RS232C interface

The cabinet E is equipped as standard with a serial interface RS232C. Using this interface it is possible to operate the cabinet from a PC. This is done with the software program „**CELSIUS for WINDOWS®**“.

If several cabinets are connected to a PC via the RS232C interface, a suitable interface on the PC and a separate cable are required for each cabinet.

The normal cable length is 15 m.

Example: Three cabinets are connected to one PC via RS232C.

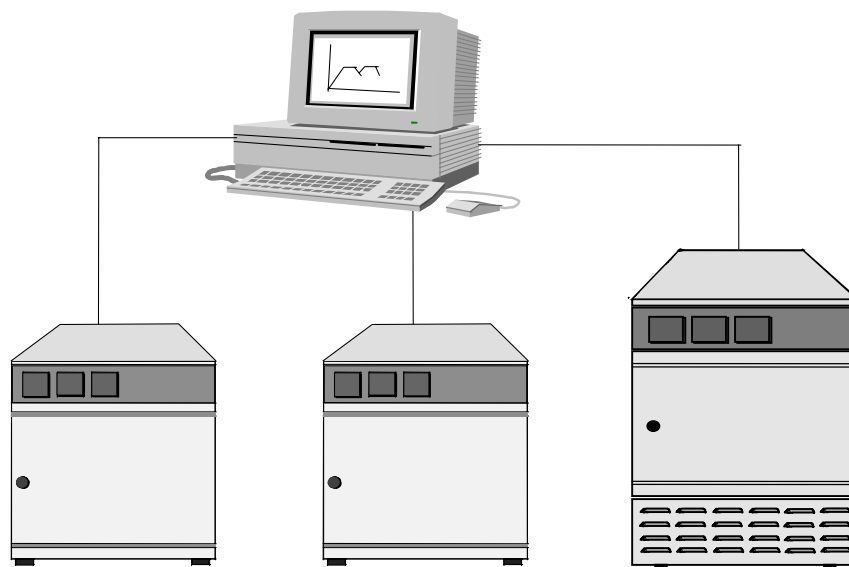



8 Controller module with main switch in position

With the main switch in position  it is possible to set programme sequences such as - delayed switch-on **delay** delayed switch-off/hold time **hold** repeat function **LP...**, set temperature dependent operation **SP...** (see examples) and on cabinets with fan the status of the fan **FA...** .

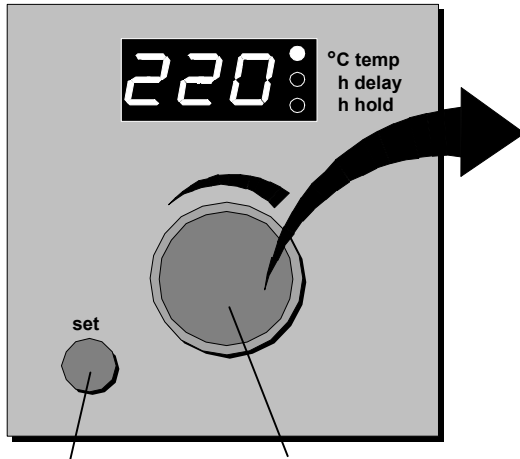

set-button rotary knob
Effect of turning the rotary knob:

Set-button not actuated

- o Selection of the menu item

temp
delay
hold
LP
SP

and additionally on cabinets with fan

FA

Set-button actuated:

- o **press:** setpoint is displayed (temperature or time, decimal point is flashing).
- o **hold down:** displayed value can be changed with the rotary knob.
- o **release:** value is stored in memory

Menu item main switch in position 

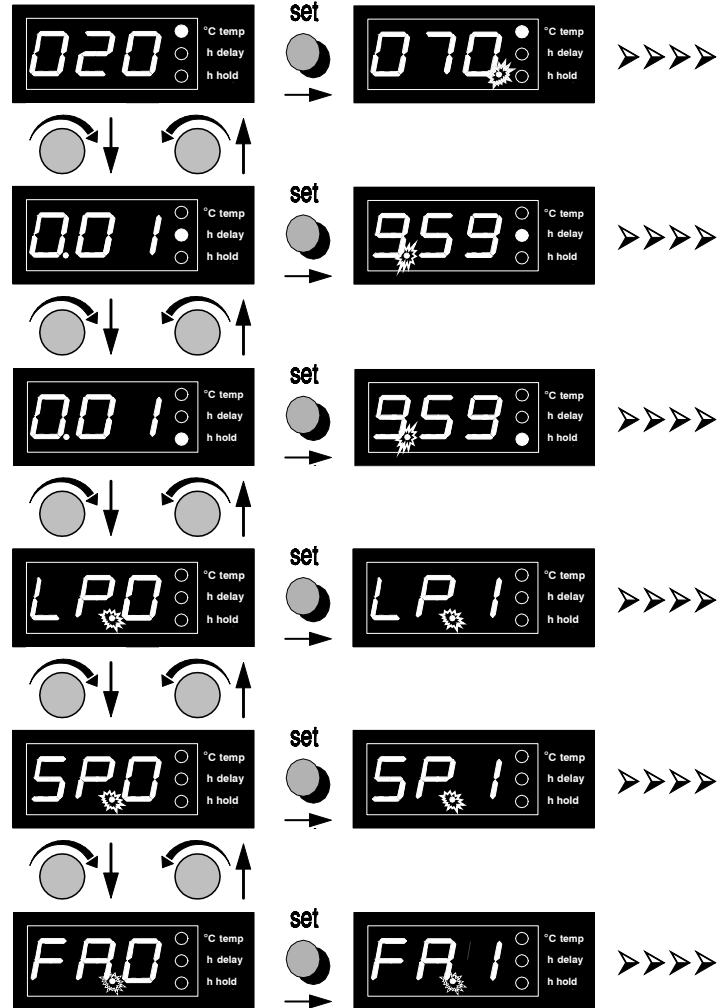



 = turn rotary knob clockwise.

 = turn rotary knob anti-clockwise.



➤➤➤  The menu item **temp** is used for setting the desired temperature

➤➤➤  **delay** is used for setting the switch-on delay.
From 1 minute to 9 hours 59 minutes the smallest setting step is 1 minute; from 10 to 999 hours the step is 1 hour.

➤➤➤  **hold** is used to set the switch-off delay or hold time.
From 1 minute to 9 hours 59 minutes the smallest setting step is 1 minute; from 10 to 999 hours the step is 1 hour.

➤➤➤ The repeat function **LOOP** ensures that a set programme sequence is repeated continuously.
LP. 0 = loop function de-activated - *LP. 1* = loop function activated

➤➤➤ A setting of the hold time **hold** in conjunction with the function **SP** ensures that on reaching the set temperature this is held for the required time.
SP. 0 = set temperature dependent hold time de-activated
SP. 1 = set temperature dependent hold time activated

➤➤➤ On cabinets with fan it is possible to switch the fan to be continuously off or on, depending on the programme.
FA 0 = fan continuously off - *FA. 1* = fan continuously on.★

★ If a programme with switch-on delay has been programmed, the fan only switches on when the delay time has elapsed and the cabinet starts to heat up.
When the set **hold** time has elapsed, the fan continues to run for 30 minutes during the cooling-down phase and is then switched off.



9 Setting of continuous operation and programmes (offline operation)

9.1 Programming of a switch-off delay

Example:

The cabinet has to shut down the heating after 2 hours operation (including heat-up time) with temperature setting at 150°C. The fan should not run.

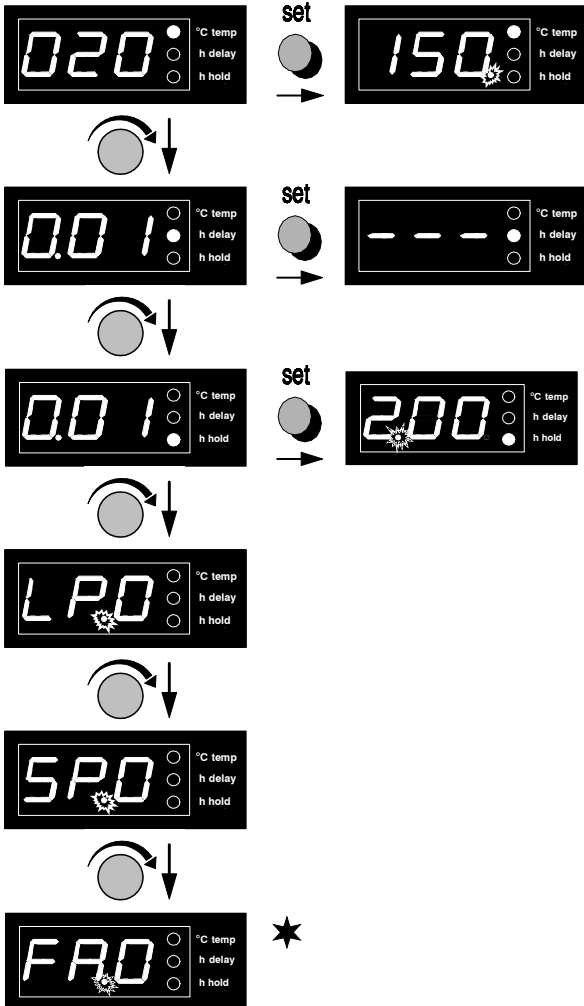
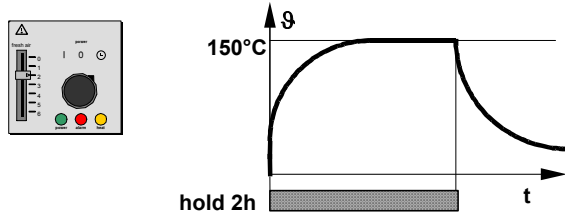

9.2 Programming of a switch-off delay, dependent on set temperature

Example:

The cabinet has to shut down the heating 2 hours after it has reached its set temperature of 150°C. The fan should run continuously.

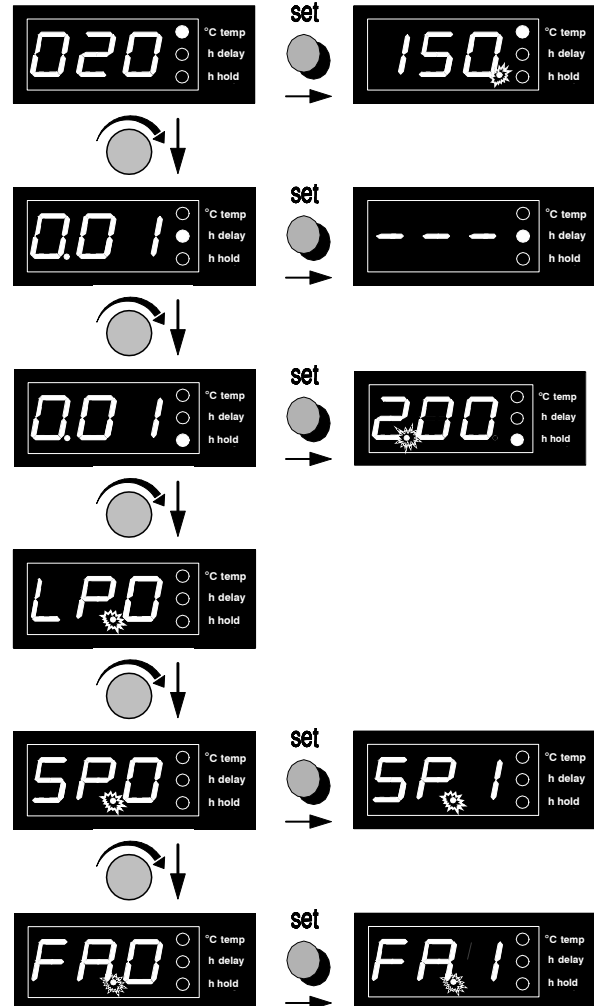
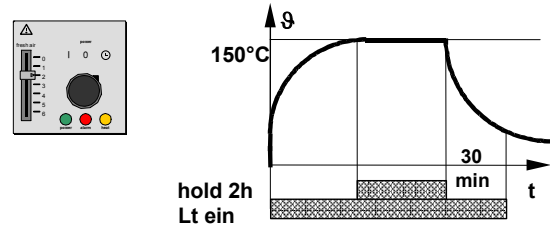

★ FA.. only indicated on cabinets with fan.



9.3 Programming of a switch-on delay

Example:

The cabinet has to start heating to 150°C after a 2 hour delay.
The fan should be switched on.

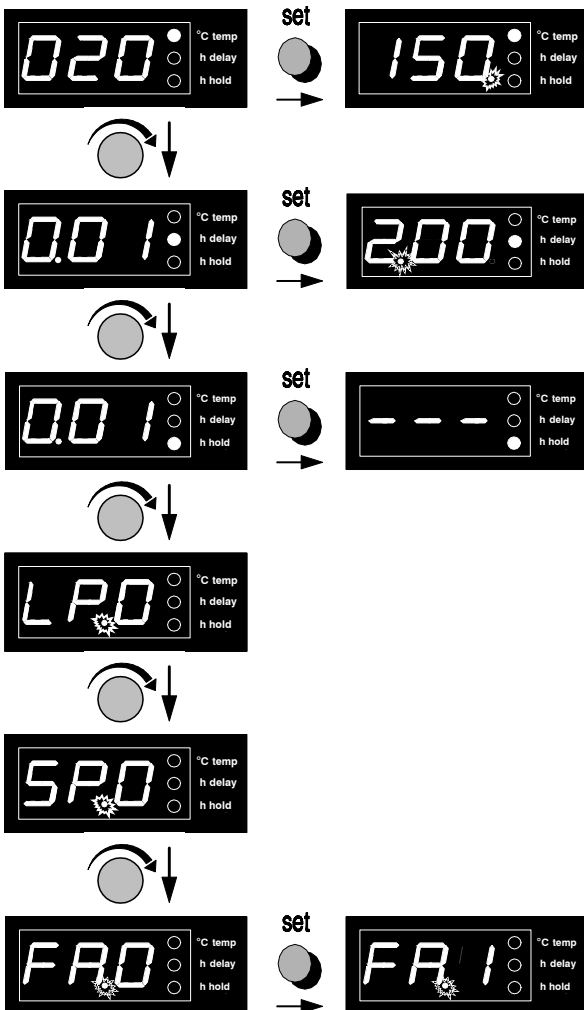
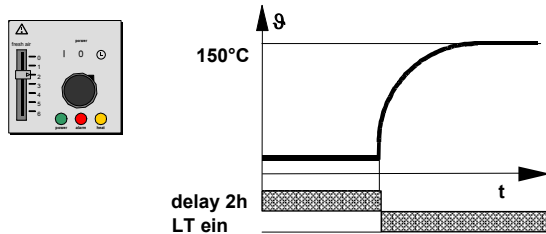

9.4 Programming of a switch-on delay and a hold time

Example:

The cabinet has to start heating to 150°C after a 2 hour delay and shut down after 3 hours operation (including heat-up time).
The fan should be switched off.

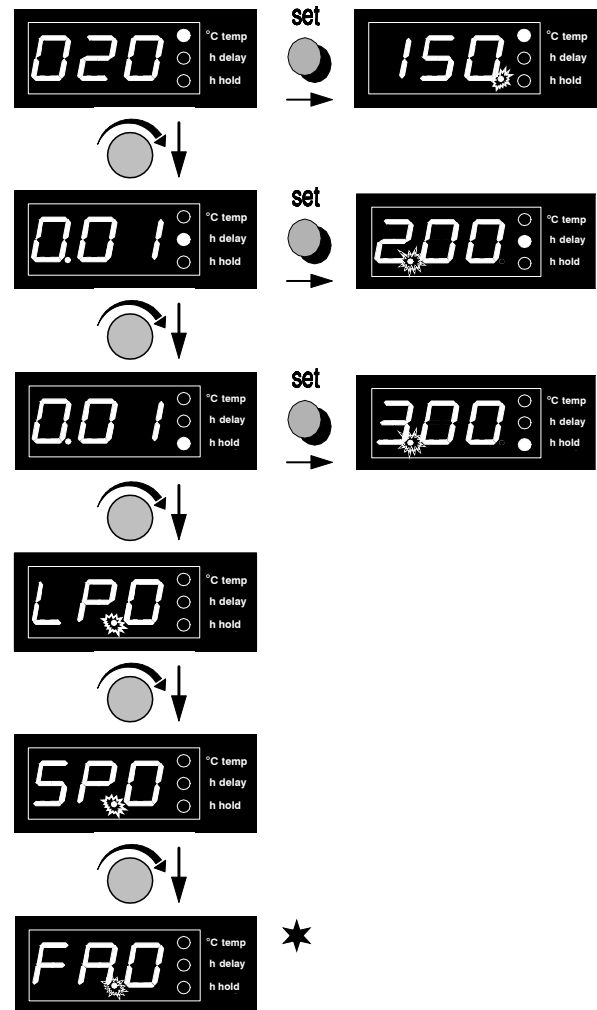
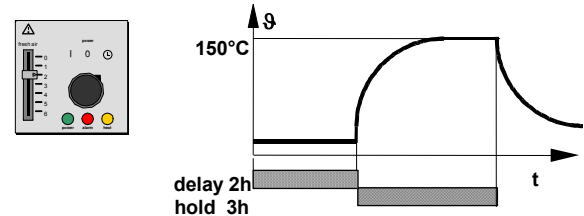

★ FA.. only indicated on cabinets with fan.



9.5 Switch-on delay and hold time dependent on set temperature

Example:

The cabinet has to start heating to 150°C after a 2 hour delay and shut down after 3 hours of operation at the set temperature. The fan should not run.

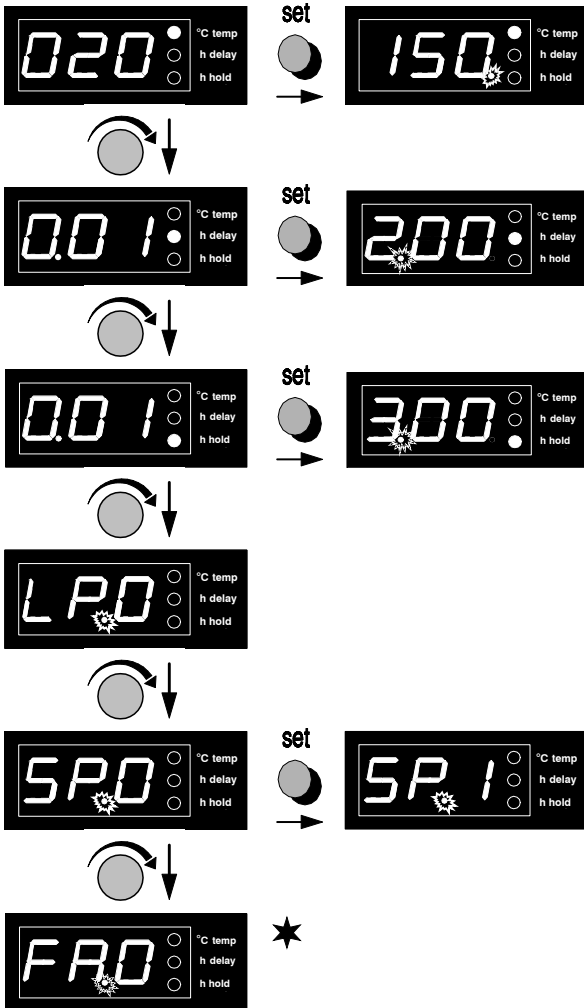
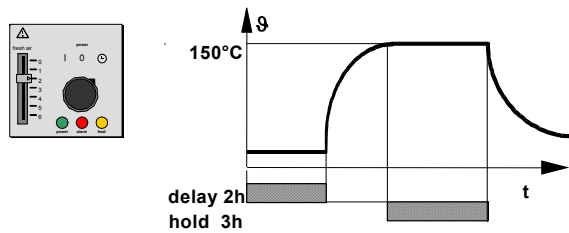

9.6 Programming of a switch-on delay and hold time with Loop-function

Example:

The cabinet has to start heating to 150°C after a 2 hour delay, cool down to room temperature after 3 hours of operation (including heat-up time) and repeat this pattern over and over. The fan should run continuously.

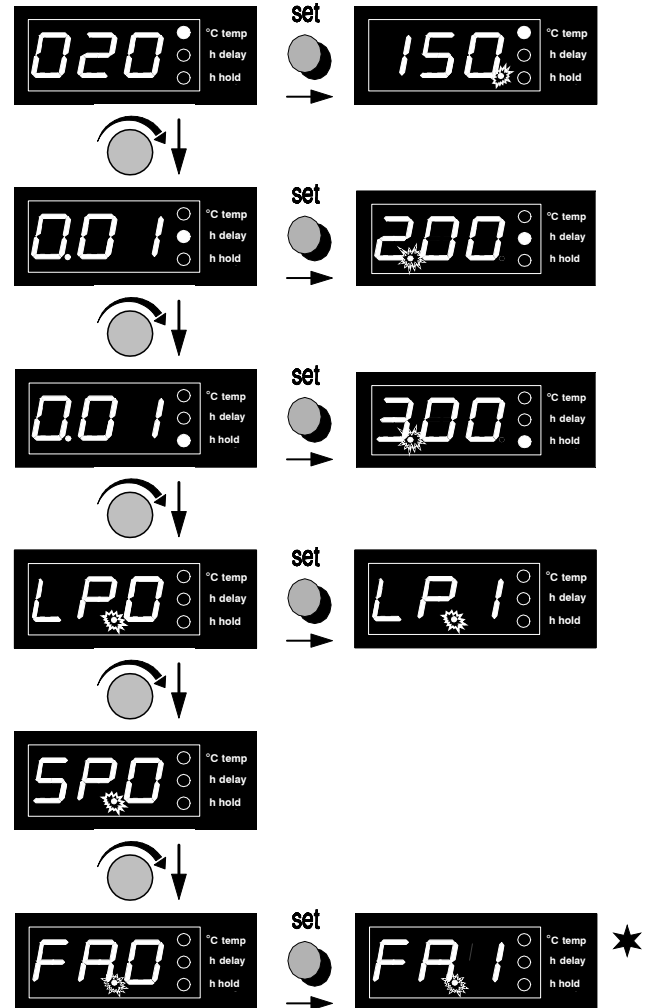
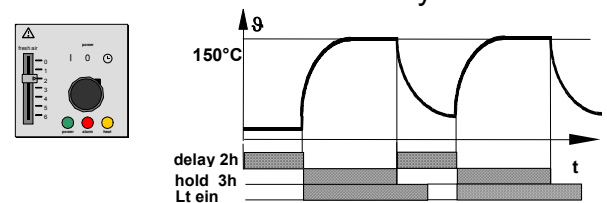

★ FA.. only indicated on cabinets with fan.

9.7 Programming of a switch-on delay and hold time with Loop-function and set temperature dependent operation

Example:

The cabinet has to start heating to 150°C after a 2 hour delay and shut down after 3 hours operation at the set temperature, cool down to room temperature and repeat this pattern over and over.

The fan should run continuously.

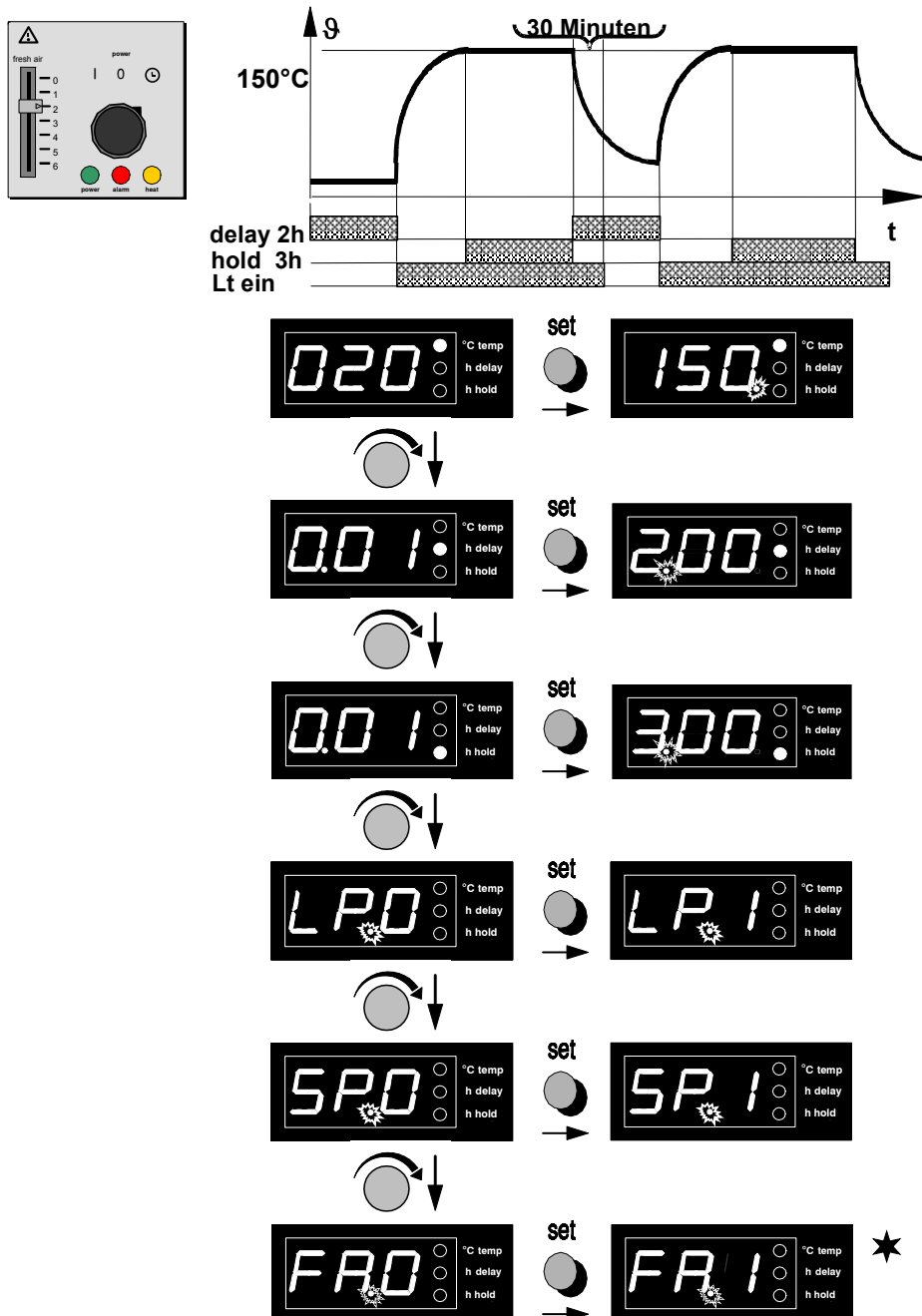

★ *FA..* only indicated on cabinets with fan.



10 Supervision of the program flow (offline operation)

The status-LEDs in the controller display give information about the program status at a glance.

Example: Delayed switch-on and delayed switch-off with set temperature dependent operation as described in example 9.5

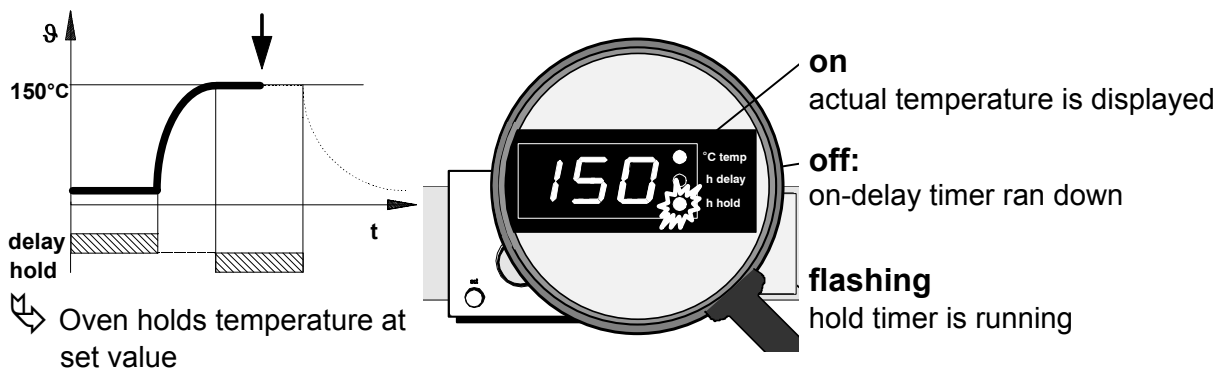
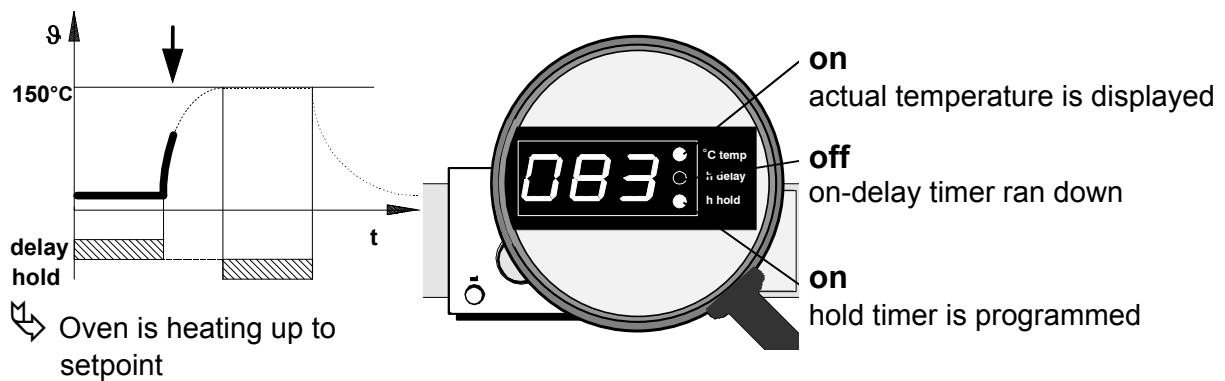
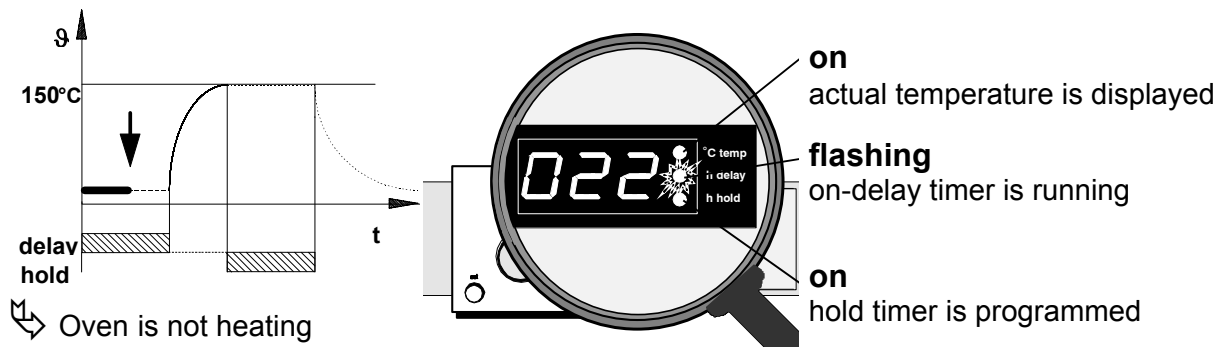

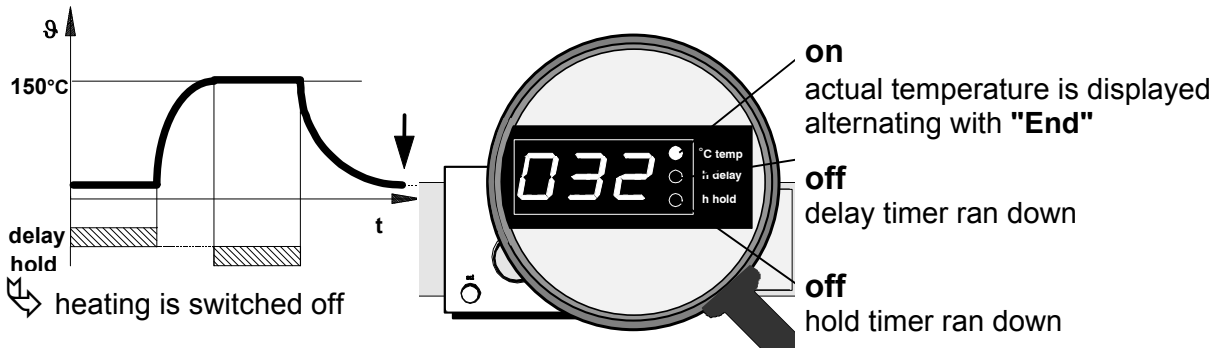

10.1 Further information during program operation:



All **actual values** can be accessed by **turning the rotary knob** (selection of the menu items) even through program operation.



The **setpoint** of each menu item can be checked by pressing the **set-button** briefly.



10.2 End of the program / Restart:



After the end of the program the actual temperature is shown alternating with "End" in the display of the working controller module. Restart by switching the unit off and on or by checking or changing the timer settings.



11 Safety devices

Adjustable overheat controller (TWW), class 3.1 and adjustable temperature limiter (TWB), class 2, work independently of the temperature control system according to DIN 12880. By different adjustments, those safety devices can have two different functions:

- Protection of cabinet and environment and
- Protection of the load from excessive temperature

The safety devices should be checked at regular intervals, e.g. once a month, once the oven has stabilized at the desired temperature. To perform this safety check, reduce the setting of the safety device until the red control light at the main switch module turns on. After that, the safety device can be set again.

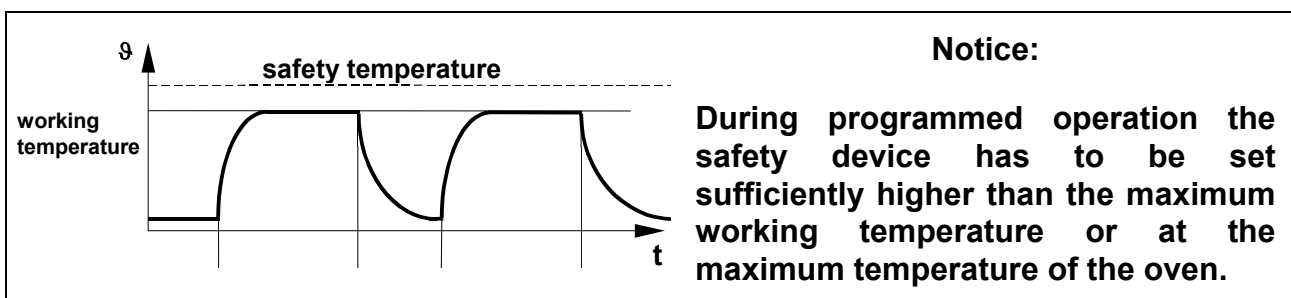

11.1 Adjustable overheat controller (TWW), class 3.1 according to DIN 12880

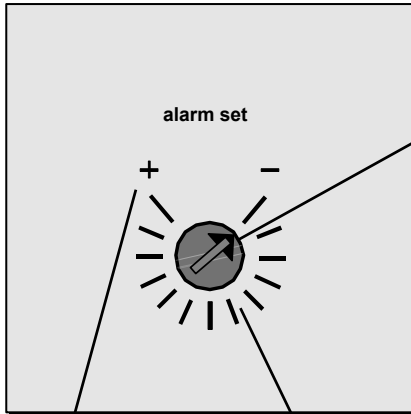

Upper temperature limit:
Protection of unit and environment

Set close to the switching point:
Protection of the load

Protection of cabinet and environment:

- Turn the adjustable overheat controller e.g. by use of a coin to upper temperature limit.

Protection of load:

- First turn adjustable overheat controller to upper limit.
- After the cabinet has stabilized, the setting of the overheat controller should be moved down until it operates.

- The red signal lamp in the main switch module turns on.

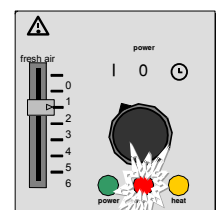

- Now turn back the overheat controller to nearly one digit higher.

Maximum temperature rating of unit	70°C	220°C	300°C
one scale line means approx.	5°C	15°C	20°C



Should the temperature rise above the set safety temperature, the adjustable over-heat controller takes over the temperature control.

- the „alarm“ lamp turns on as soon as the TWW has switched off the heating

In this case please check the TWW setting as described and readjust it if necessary. Should a fault condition be present, please contact an authorized service station for Memmert equipment.

11.2 Adjustable temperature limiter (TWB), class 2 according to DIN 12880

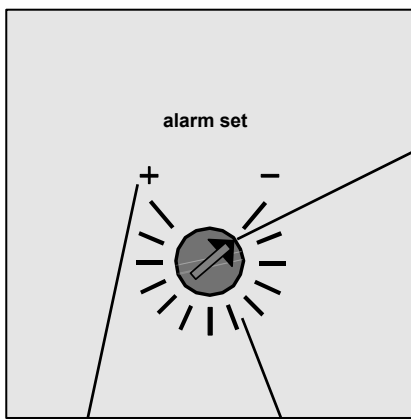

Upper temperature limit:
Protection of unit and environment

Set close to the switching point:
Protection of the load

Protection of cabinet and environment:

- Turn temperature limiter e.g. with a coin to upper temperature limit.

Protection of load:

- First turn temperature limiter to upper temperature limit.
- After the cabinet has stabilized, the temperature limiter should be moved down until it operates.

- The red signal lamp in the main switch module lights up.

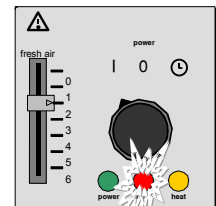

- Now turn back the temperature limiter to nearly one digit higher.
- The temperature limiter must be reset by pressing the adjustment knob.

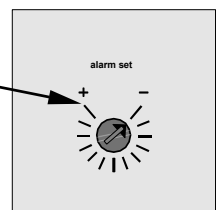

Maximum temperature rating of unit	70°C	220°C	300°C
one scale line means approx.	5°C	15°C	20°C

Should the temperature rise above the set safety temperature, the adjustable temperature limiter switches off the heating.

- the „alarm“ lamp turns on.

In this case please check the TWB setting as described and readjust it if necessary. Should a fault condition be present, please contact an authorized service station for Memmert equipment.



12 Loading



Cabinets described in this instruction manual must not be used for drying or warming substances which generate ignitable vapours when mixed with air.

The cabinets described here must never be operated in areas with an explosive atmosphere.

For correct operation and uniform temperature distribution it is essential to maintain free air circulation throughout the oven. The contents of the oven should therefore not be packed tightly, furthermore they must not be placed close to any of the heating ribs on the sides, top or bottom of the oven (note the loading diagrams on the ovens).

In order to ensure optimum air circulation the shelves should be arranged to have roughly equal gaps between door, shelf and the rear of the working chamber. For the maximum number of shelves with the permissible load, see table below.

In the event that the load is packed tightly and the ventilation slide is fully open the oven may take a very long time to reach the set temperature.

The following schedule gives recommended loading levels which will ensure homogeneous temperature distribution within the working chamber.

Model	Max. number of shelves	Load each shelf max. kg	Total load kg
200	3	15	30
300	3	12	30
400	4	30	90
500	5	30	60
600	7	30	80
700	8	30	100
800	10	30	160



13 Sterilisers

13.1 Application

The apparatus is used for sterilizing medical materials by employing dry heat through hot air at atmospheric pressure

13.2 Directives for sterilisation in MEMMERT- hot-air sterilisers.

For the hot air sterilisation, many directions exist concerning the temperatures and sterilisation times to be selected as well as the packaging of the sterilisation goods. The data to be selected, depend on the nature of the goods to be sterilised and on the type of the germs to be deactivated. Please make yourself familiar with the applicable direction for your application before carrying out a sterilisation with your MEMMERT steriliser.

Some examples for the correct preparation of different medical instruments are shown in the following table:

Charging	Preparation
Instruments with no soft soldered parts	Place the cleaned instruments, twin-packed in aluminium foil (recommendable)
Sharp Instruments or blades	Place the cleaned instruments, twin-packed in aluminium, foil (recommendable)
Modern Syringes	Place flasks and cylinders separately, twin-packed in aluminium foil (recommendable)
Glass and glass instruments	Disassemble the cleaned glass containers and glass syringes. Place on trays-cool slowly

Bottles and similar items must be sterilised with the opening pointing downward in order to prevent the development of cold air nests. Organic fabrics (e.g. cork) must not be used as closing material for bins.

180°C are usually recommended as sterilising temperature (cf. e.g., German drug book DAB 10 or other national standards).

For sterilisation, the set temperature dependent operation should always be used. The applicable hold time consists of the equalizing time (i.e. the time it takes until the desired temperature is reached at any point of the working chamber), of the actual extinction time and the safety surcharge.

The following table shows rough values for the hold time to be selected at the controller, in dependence of the weight of the sterilising load for cabinets with and without air turbine (fan). Please note, that this data can only be applied for correct, loose loading. Information on the right loading of the unit are given in this operation manual and on the adhesive label directly on the cabinet.

Sterilisation temperature 180°C	Weight of the load (see chapter 12)					
	low		medium		high	
Unit size	without fan	with fan	without fan	with fan	without fan	with fan
200	0.50 h	-	1.20 h	-	1.50 h	-
300	0.50 h	-	1.20 h	-	1.50 h	-
400	1.10 h	1.00 h	1.50 h	1.20 h	2.00 h	1.50 h
500	1.10 h	1.00 h	1.50 h	1.20 h	2.00 h	1.50 h
600	1.30 h	1.00 h	2.20 h	1.30 h	2.20 h	2.20 h
700	1.30 h	1.00 h	2.20 h	1.30 h	2.20 h	2.20 h
800	1.40 h	1.10 h	2.20 h	1.40 h	2.50 h	2.20 h

The sterilisation time has to be multiplied by about 4, if a sterilisation temperature of 160°C is selected.

With large units and heavy loads, the use of grates (option) is recommended instead of the perforated shelves.



In particular with heavy loads, the untested usage of these provisional values is not sufficient. For a safe sterilisation, a validation of the individual sterilisation process must be done, using e.g. additional temperature sensors or germ packets.

When sterilising the air flap has to be closed after the humid load has been dried.

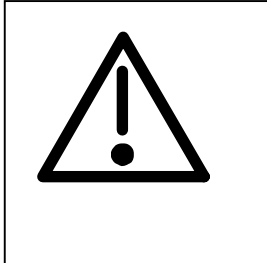

WARNING!

Models 700 and 800 are fitted with a door closure mechanism incorporating a lock. If the user, against our express warning, enters the interior of the steriliser it is essential that he first pulls off the key and keeps it on his person.

13.3 Notes on the work with sterilising cassettes:

The cassettes should be placed in the apparatus so that the hot air can flow easily through the air ducts (in an oven with air turbine the airstream flows crosswise through the working space). The directives about correct loading, which can be found in this operating manual and on the unit have to be followed also when using sterilising cassettes. This makes sure that a good temperature distribution is obtained and that the development of cold air nests is prevented.

The sterilisation load must be packed in aluminium foil as shown in the table and must be placed in the sterilising cassettes. The **air ducts** of the box **must be opened** for sterilising. A temperature sensor for the verification of the temperature can be brought into the sterilising cassette through opening 2.

After the sterilising time has elapsed, the **air ducts must be closed** by shifting knob 1 in the direction of the arrow.

In this way, the sterilised goods can be preserved in the closed cassette for some days.

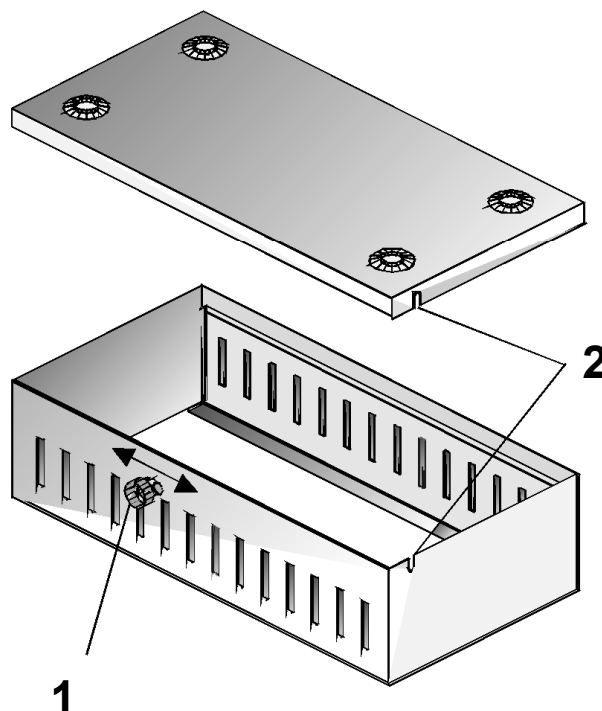



14 Sterilisation programme

14.1 Example – Steriliser SLE 600:

The cabinet has to sterilise at a temperature of 180°C for 1 hour 30 minutes with an average weight of the load.

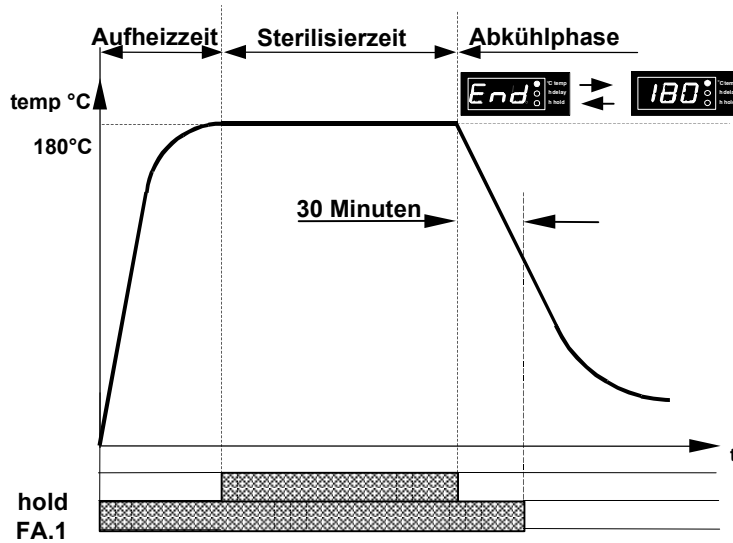

Menu item

main switch in position

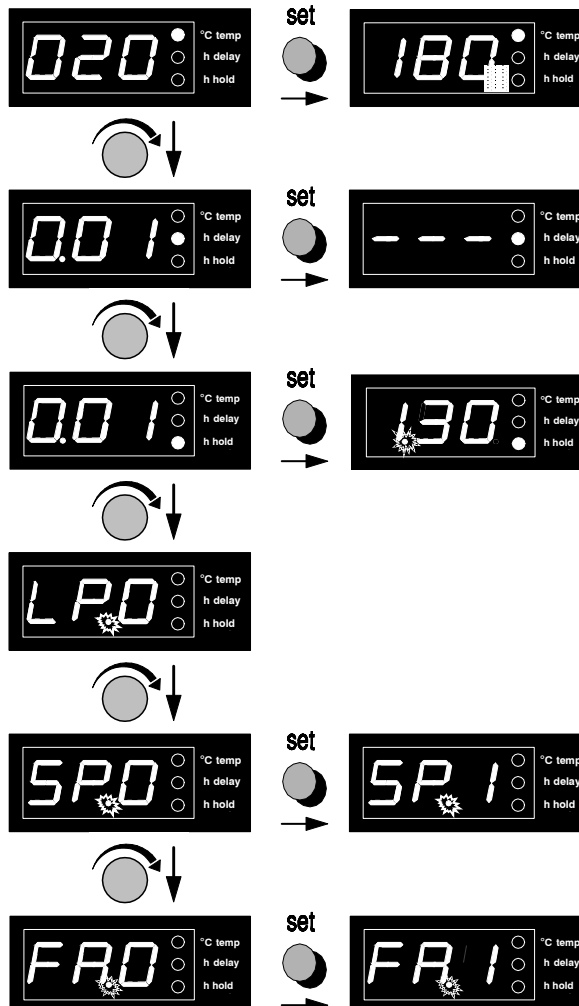
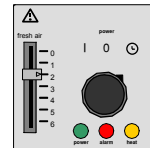

FA. only indicated on cabinets with fan.



During the sterilisation programme the display of the working controller always shows the actual cabinet temperature. On pushing the **set-button** the display shows the programmed setpoint temperature.

The sterilisation programme may be interrupted through a supply failure or through opening the door. After the fault has been rectified and the setpoint temperature has again been reached, the sterilisation process is restarted from the beginning in order to ensure reliable sterilisation (see graph).

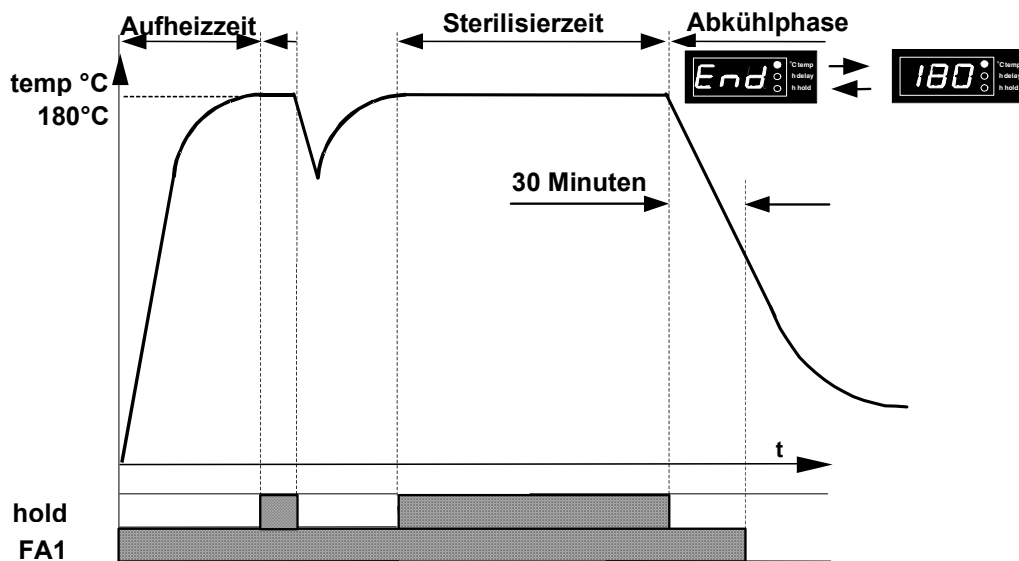

15 Door interlock (option)

On cabinets provided with a door interlock, the doors are locked throughout the entire sterilisation programme.

In case of a supply failure or when the cabinet is switched off, the doors are unlocked for safety reasons.

16 Maintenance

General information

Memmert appliances require minimal servicing. It is recommended, that the moving parts on the doors (hinges and door lock) should be lubricated with a thin silicone grease once a year (with continuous use 4 times a year).

In case of a malfunction which makes the opening of the cabinet necessary this work has to be performed by a qualified service engineer.

A tightly closing door is an essential requirement for proper operation of the oven. MEMMERT-ovens ensure perfectly tight closing of the door through a seal on the oven casing. The door seal presses accurately against the casing seal. In continuous operation the flexible seal material may acquire a permanent set. For proper closing of the door it may be necessary to adjust the hinge or the locking plate.

16.1 Readjusting the door

After releasing the screw No.12 (**ATTENTION!** Screw No. 12 is secured with glue. Loosen jerky with inner hexagon key wrench 2 mm) the door can be adjusted by turning the eccentric 13 in the direction of the arrow (using a screwdriver). Tighten screw No. 12 again.

In addition the upper part No.14 of the door hinge can be moved slightly in the direction of the arrow after releasing the 2 screws at the top or bottom of the door.

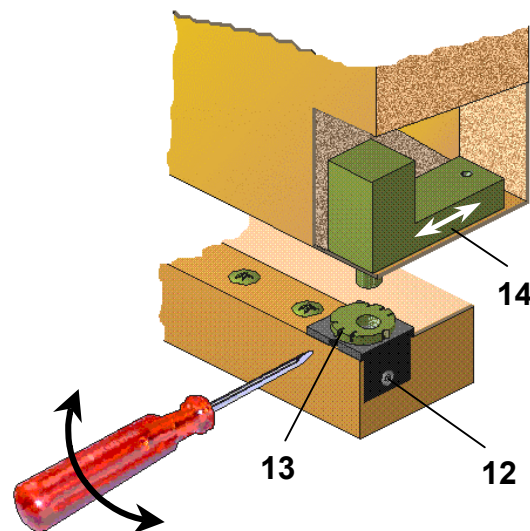

The locking plate can also be readjusted in the direction of the arrow after releasing the screw No.15.

Ensure that the cover is again screwed down tightly.

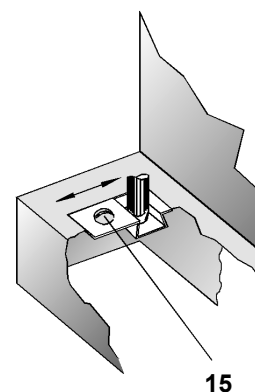



17 Cleaning



By regular cleaning of the (easy to clean) interior, residues are avoided which may impair the outfit and function of the oven.

The cabinet can be cleaned with commercial stainless steel cleaning agent. Please note that objects liable to rust must not be placed into the interior. Rust sediments lead to contamination of the interior or the external casing.

If rust stains caused by contamination occur on the interior surface, the affected areas must be cleaned and polished immediately.

18 Check list for rectifying faults

<u>Fault</u>	<u>Cause</u>
Main switch in position I, green lamp in main switch-module remains dark	Equipment not connected Lamp faulty Main fuse defective
No temperature indication on the display	Microfuse defective T32mA 250 V~ on printed wiring board 55139.x
Yellow lamp in main switch module remains dark	Ambient temperature too high, working temperature in oven higher than the working temperature set with rotary knob (setpoint). Lamp faulty
Red lamp in main switch module lighted	Temperature safety device is actuated (see chapter 7).
Display <i>E-0</i> in working controller module	Fault on self-test
Display <i>E-1</i> in working controller module	Circuit element TRIAC defective, send controller back to Memmert for exchange.
Display <i>E-2</i> in working controller module	Power board defective, send controller back to Memmert for exchange.
Display <i>E-3</i> in working controller module	PT100 defective
Display <i>E-4</i> in working controller module	Internal Configuration Error, Turn off the oven, then turn it back "on".

In case of a malfunction contact an authorized service station for Memmert equipment or please inform the Memmert service department.



The details in these Operation Instructions must be carefully observed in order to ensure satisfactory operation.

Any warranty and claims for damage are excluded if these instructions are disregarded.

**We reserve the right to make changes in technical specifications.
Dimensions subject to confirmation.**

Standard ovens (UE / ULE / BE) are safety-approved and bear the test marks:

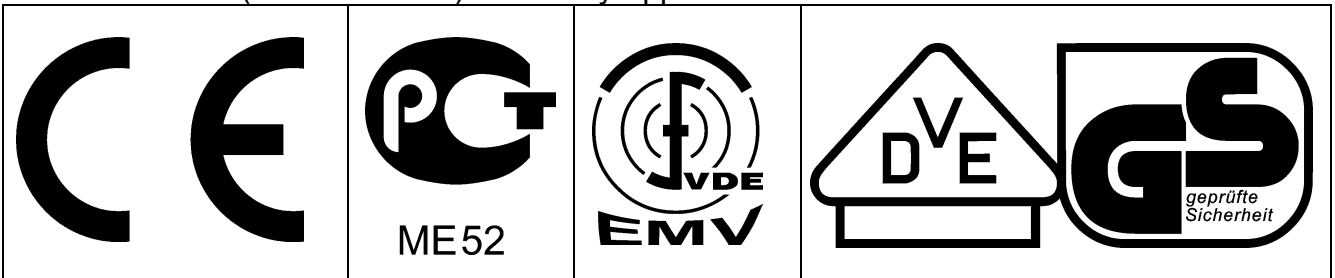

Sterilisers (SE / SLE) are safety-approved and bear the test marks:



19 Our Address



MEMMERT GmbH+Co.KG
P.O.Box 17 20, 91107 Schwabach
Federal Republic of Germany
☎: +49 9122 / 925-0
Fax: +49 9122 / 14585
Internet: www.memmert.com

Direct dialling-in service department:
☎: +49 9122/925-143
E-Mail: service@memmert.com

© by MEMMERT GmbH+Co.KG



EC Declaration of Conformity

Manufacturer's name and address: MEMMERT GmbH + Co. KG
Äußere Rittersbacher Straße 38
D-91126 Schwabach

Product: Universal oven

Type: UM ... / ULM ... / UE ... / ULE ... / UP ... / ULP ...

Sizes: 100 / 200 / 300 / 400 / 500 / 600 / 700 / 800

Nominal voltage: AC 230 V or 3 ~ AC 400 V 50 / 60 Hz
alternative AC 115 V 50/60 Hz

The designated product is in conformity with the European EMC-Directive

89/336/EEC
including amendments

Council Directive of 03 May 1989 on the approximation of the laws of the Member States relating to electromagnetic compatibility.

Full compliance with the standards listed below proves the conformity of the designated product with the essential protection requirements of the above-mentioned EC Directive:

DIN EN 61 326 (VDE 0843 part 20): 1998-01	EN 61 326: 1997
DIN EN 61 326/A1 (VDE 0843 part 20/A1): 1999-05	EN 61 326: 1997/A1 : 1998
RFI suppression: Class B	
DIN EN 61 000-3-11 (VDE 0838 part 11): 2001-04	EN 61 000-3-11: 2000

The designated product is in conformity with the European Low Voltage Directive

73/23/EEC
including amendments

Council Directive on the approximation of the laws of the Member States relating to Electrical equipment for use within certain voltage limits.

Full compliance with the standards listed below proves the conformity of the designated product with the essential protection requirements of the above-mentioned EC Directive:

DIN EN 61 010-1 (VDE 0411 part 1): 1994-03	EN 61 010-1: 1993
DIN EN 61 010-2-010 (VDE 0411 part 2-010): 1995-03	EN 61 010-2-010: 1994

Schwabach, 13.01.03



(Legally binding signature of the issuer)

This declaration certifies compliance with the above mentioned directives but does not include a property assurance. The safety note given in the product documentation which are part of the supply, must be observed.



EG-Konformitätserklärung

Manufacturer's name and address: MEMMERT GmbH + Co. KG
Äußere Rittersbacher Straße 38
D-91126 Schwabach

Product: Steriliser

Type: SM ... / SLM ... / SE ... / SLE ... / SLP ...

Sizes: 100 / 200 / 300 / 400 / 500 / 600 / 700 / 800

Nominal voltage: AC 230 V oder 3 ~ AC 400 V 50 / 60 Hz
alternative AC 115 V 50/60 Hz

The product meets the regulations of the directive

93/42/EWG

Directive of the council to adapt legal regulations of the member states on the subject of medical products dd. 14.06.1993 (Abl. EG Nr. L 169, S. 1, 12.07.1993) including annex and modifications.

Schwabach, 13.01.03



(Legally binding signature of the issuer)

This declaration certifies compliance with the above mentioned directives but does not include a property assurance. The safety note given in the product documentation which are part of the supply, must be observed.



EC Declaration of Conformity

Manufacturer's name and address: MEMMERT GmbH + Co. KG
Äußere Rittersbacher Straße 38
D-91126 Schwabach

Product: Incubators
Type: BE ... / BP ...
Sizes: 200 / 300 / 400 / 500 / 600 / 700 / 800
Nominal voltage: AC 230 V 50/60 Hz
alternative AC 115 V 50/60 Hz

The designated product is in conformity with the European EMC-Directive

89/336/EEC *including amendments*

Council Directive of 03 May 1989 on the approximation of the laws of the Member States relating to electromagnetic compatibility.

Full compliance with the standards listed below proves the conformity of the designated product with the essential protection requirements of the above-mentioned EC Directive:

DIN EN 61 326 (VDE 0843 part 20): 1998-01	EN 61 326: 1997
DIN EN 61 326/A1 (VDE 0843 part 20/A1): 1999-05	EN 61 326: 1997/A1 : 1998
RFI suppression: Class B	
DIN EN 61 000-3-11 (VDE 0838 part 11): 2001-04	EN 61 000-3-11: 2000

The designated product is in conformity with the European Low Voltage Directive

73/23/EEC *including amendments*

Council Directive on the approximation of the laws of the Member States relating to Electrical equipment for use within certain voltage limits.

Full compliance with the standards listed below proves the conformity of the designated product with the essential protection requirements of the above-mentioned EC Directive:

DIN EN 61 010-1 (VDE 0411 part 1): 1994-03	EN 61 010-1: 1993
DIN EN 61 010-2-010 (VDE 0411 part 2-010): 1995-03	EN 61 010-2-010: 1994

Schwabach, 13.01.03



(Legally binding signature of the issuer)

This declaration certifies compliance with the above mentioned directives but does not include a property assurance. The safety note given in the product documentation which are part of the supply, must be observed.



20 Index

	page		page
A			
address	28		
adjustable temperature limiter.....	20		
alarm	20		
alarm set	20		
C			
CELSIUS for WINDOWS®	3, 9		
check list for rectifying fault.....	27		
cleaning.....	27		
communication protocol	10		
computer connection.....	10		
controller module	11		
current-connection	4		
D			
declaration of conformity be.....	28		
declaration of conformity ue/ule	29		
declaration of conformity se/sle	30		
delay	11, 12, 14, 15, 16, 18		
door hinge	26		
door interlock (option)	25		
E			
<i>E-0</i>	27		
<i>E-1</i>	27		
<i>E-2</i>	27		
<i>E-3</i>	27		
<i>E-4</i>	27		
electrical supply	4		
end of the program.....	18		
explanation of symbols	2		
F			
<i>FA</i>	9, 11, 12, 13, 14, 15, 16, 24		
fresh air	7		
fresh air control	7		
further information during prog. operation	18		
H			
handling of the door	6		
heat	12		
hold	11, 12, 14, 15, 16, 17, 18, 22		
I			
installation options.....	5		
L			
loading.....	21		
locking plate	26		
loop-function.....	15, 16		
<i>LP</i>	11, 12		
M			
main switch module.....	7		
maintenance.....	26		
multifunctional display	8		
O			
offline operation.....	3		
online operation.....	3		
overheat controller tww	19		
overheat safety device	21		
P			
itches of holes for wall fixation.....	5		
power.....	3, 4		
programming of a switch-off delay	13		
programming of a switch-off delay dependent on set temperature	13		
programming of a switch-on delay	14		
programming of a switch-on delay and a hold time.....	14		
programming of a switch-on delay and a hold time with loop-function.....	15		
programming of a switch-on delay and a hold time with loop-function and set temperature dependent operation	16		
putting into operation.....	6		
Q			
quality of material	4		
R			
readjusting the door.....	26		
restart	18		
rotary knob	8, 9, 11		
RS232C interface	10		
rust sediments	27		

..... page

S

safety device	19
safety instructions	2
shocks during transport.....	6
serial communication interface	10
set	8, 9, 11, 18
set-button	8, 9, 11, 18, 25
setting of continuous operation and programmes	13
<i>SP</i>	11, 12
stacking device	5
sterilisation	22, 24
sterilising cassettes.....	23
supervision of the programm flow	17
switch-on delay and hold time dependent on set temperature	15

.....page

T

technical data summary	3
temp	12
temperature controller	8
temperature range.....	3
temperature setting	9, 11
timer setting.....	11, 12
transport	2

W

wall mounting	5
working controller module	8, 9
working temperature range	3

21 Glossar:

- **nominal temperature** = the maximum adjustable set-temperature of the oven.
- **ambient temperature** = the continuous temperature of the room in which the oven is set up
- **set temperature dependent on operation** = the integrated digital timer for the hold time starts not earlier than the temperature in the chamber has reached the setpoint to at least 0.5°C at 70°C nominal temperature resp. 2°C at 220/300°C nominal temperature.
- **steady-state condition** = the selected set temperature was reached and is stabilized, i.e. the setpoint is unvaried at least for 5 minutes.

